

190-766-190 8 HP Tiller Attachment (1989)
Chain Case Assembly

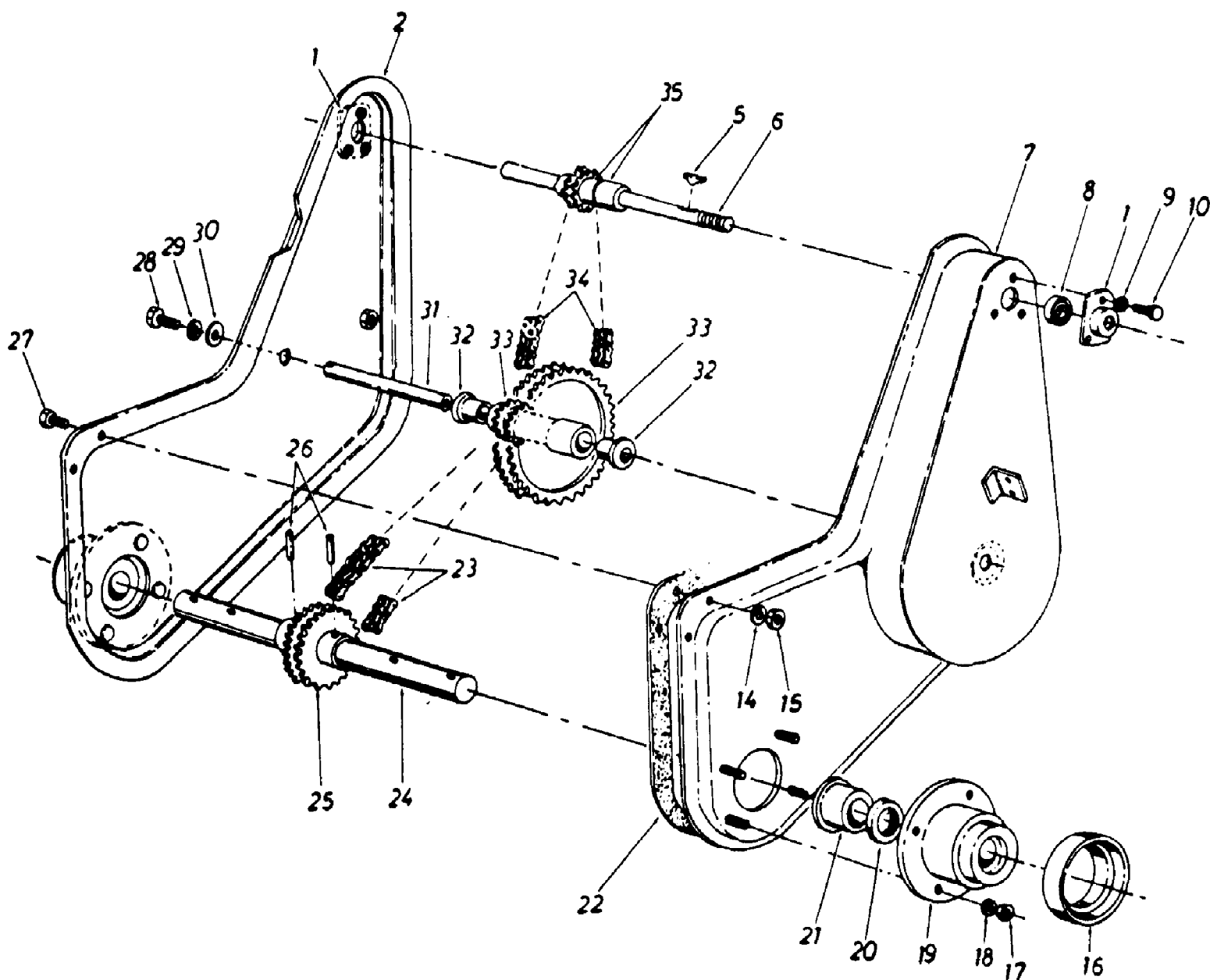

190-766-190 8 HP Tiller Attachment (1989)
Chain Case Assembly

Page 2 of 5

Ref #	Part Number	Qty	S/P/F	Description
1	05034	1	S	Bearing Housing 1.375" Dia.
2	14895	1	S	Housing Assembly R.H.
5	714-0136	1	/P	#6 Hi-Pro Key 5/32" x .62" Lg.
6	14892	1	S	Input Shatt Assembly
7	14894	1		Housing Assembly L.H.
8	741-0155	1	S	Ball Bearing .62" I.D. x 1.38" O.D.
9	736-0329	1	S	L Wash. 1/4" I.D.
10	710-0258	1	S	Hex Bolt 1/-20 x .62" Lg.
14	736-0329	1	S	L Wash. 1/4" I.D.
15	712-0287	1	S	Hex Cent. L-Nut 1/4-20 Thd.
16	04973	1		Dust Cap Cover
17	712-0158	1	S	Hex Cent. L-Nut 5/16-18 Thd.
18	736-0119	1	S	L-Wash. 5/16" I.D.
19	04530	1	S	Cast Bearing Housing
20	721-0117	1	S	Oil Seal
21	748-0194	1	/P	Flange Bearing 1.25" I.D. x 1 .75" O.D.
22	721-0119	1		Gasket
23	713-0150	1	S	Roller Chain #40-2 x 34.0 0 Lg.
24	711-0506	1		Tine Shaft
25	717-0189	1		Double Sprocket T24-2 Teeth 1/2" Pitch
26	715-0125	1	S	Spiral Pin 3/8" Dia. x 2.00" Lg.
27	710-0258	1	S	Hex Bolt 1/4-20 x .62" Lg.
28	710-0118	1	S	Hex Bolt 5/16-18 x 75" Lg.
29	736-0119	1	S	L-Wash. 5/16 I.D.
30	736-0195	1	/P	FI-Wash. 5/16 I.D.
31	711-0504	1		Sprocket Shaft
32	748-0855	1	/P	Flange Bearing .62 I.D. x .75 O.D.
33	04529	1	/P	Double Sprocket Assembly
34	713-0149	1		Roller Chain #35-2 x 36.75" Lg.
35	748-0192	1	/P	Spacer 5/8 I.D. x 7/8" O.D.

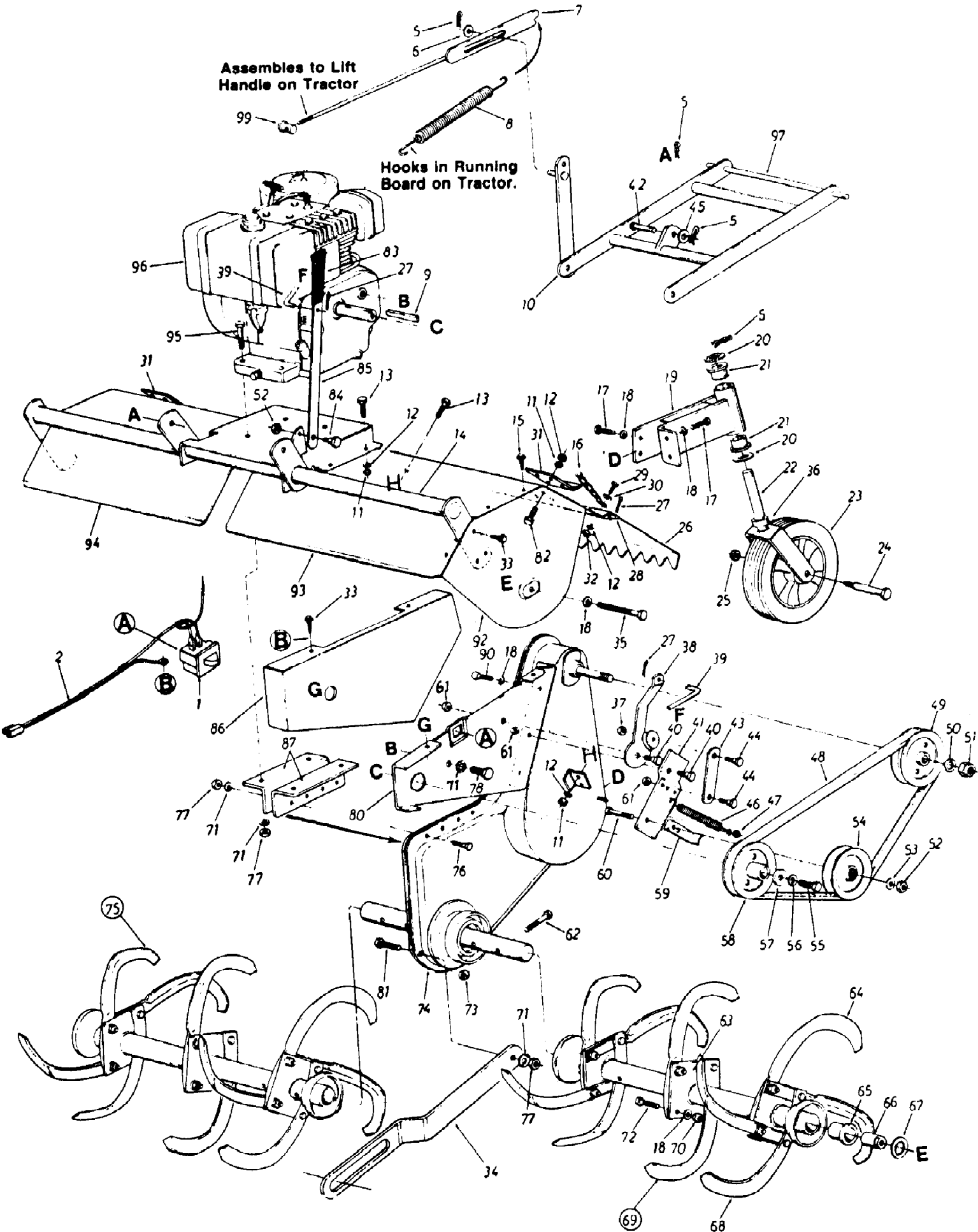

Ref #	Part Number	Qty	S/P/F	Description
1	725-0713	1		Safety Switch
2	725-1290	1		Wire Harness
5	714-0147	1		Internal Cotter Pin
6	736-0179	1	S	FI-Wash. 1/2" I.D. x .93" O.D.
7	04997	1	F	Link Rod Assembly
8	732-0390	1	F	Extension Spring 1.25" O.D. x 12.75" Lg.
9	714-0114	1	S	Sq. Key 1/4" X 1/4" X 2.00" Lg.
10	04993	1		Hitch Bar Assembly
11	712-0138	1	S	Hex Nut 1/4-28 Thd.
12	736-0329	1	S	L-Wash. 1/4" I.D.'
13	710-0195	1	S	Hex Bolt 1/4-28 x .62" Lg.
14	04966	1	S	Support Frame Assembly
15	710-0429	1	S	Hex Hd. "B"-Tap Scr. #10 0 x .62" Lg .
16	727-0225	2		#2 Dog Chain x 20 Lg.
17	710-0623	1	/P	Hex Wash. Hd. Self-Tap Scr. 3/8-24 x .75" Lg .
18	736-0169	1	S	L-Wash. 3/8" I.D.
19	04978	1	S	Swivel Wheel Support
20	736-0188	1	/P	FI-Wash. 3/4" I.D. x 1.50" O.D.
21	741-0382	1	S	Flange Bearing 3/4" I.D. x 1.00" O.D.
22	04981	1	S	Swivel Wheel Caster
23	734-0979	1		Wheel Assembly 10.0 x 2.75
24	738-0476	1		Shoulder Bolt .623" I.D. x 3.62" Lg.
25	712-0290	1	/P	Hex Cent. L-Nut 7/16-14 Thd.
26	04985	1	S	L.H. Shield Hinge Flap
	04986	1		R.H. Shield Hinge Flap (Not Shown)
27	714-0115	1	S	Cotter Pin 1/8" Dia. x 1.00" Lg.
28	747-0340	1		L.H. Flap Rod
	747-0339	1		R.H. Flap Rod (Not Shown)
29	710-0258	1	S	Hex Bolt 1/4-20 x .62" Lg.
30	736-0173	1	/P	FI-Wash. 1/4" I.D.
31	14891	1		Brace-Tine Shield
32	712-0287	1	S	Hex Nut 1/4-20 Thd.
33	710-0776	1	S	Hex Wash. Hd. Self Tap Scr. 1/4" x.62" Lg.
34	14890	1	S	Stabilizer Link
35	710-0342	1	S	Hex Bolt 3/8-16 x 1.25" Lg.
36	711-0469	1		Spacer .752" I.D. x 1.25" O.D.
37	712-0158	1	S	Hex Cent. L-Nut 5/16-18 Thd.
38	04987	1		Clutch Lever
39	747-0379	1		Clutch Rod
40	738-0140	1	S	Shoulder Bolt 7/16" Dia. x 1.75" Lg.
41	04992	1		Idler Bracket
42	711-0310	1	S	Clevis Pin
43	747-0342	1	S	Clutch Link 3.62" Lg.
44	738-0155	1	S	Shoulder Bolt .435" Dia. x .160" Lg.
45	736-0273	1	S	FI-Wash. .50" I.D. x 1.0" O.D. x .06
46	732-0384	1	S	Extension Spring .62" O.D. x 6.12" Lg.
47	712-0214	1	S	Hex Crown Nut 3/8-24 Thd.
48	754-0253	1	S	"V"-Belt (Kevlar)
49	756-0351	1		1/2" "V"-Pulley 4.75" O.D. x .625" Bore
50	736-0158	1	S	L-Wash. 5/8" I.D.
51	712-0221	1		Hex Ins. L-Nut 5/8-18 Thd.

Ref #	Part Number	Qty	S/P/F	Description
52	712-0375	1	/P	Hex Cent. L-Nut 3/8-16 Thd.
53	736-0140	1	S	FI-Wash. 3/8" I.D.
54	756-0293	1	S	Idler Pulley 4.0" O.D.
55	710-0314	1	/P	Hex Bolt
56	736-0171	1	S	L-Wash. 7/16" I.D.
57	736-0319	1	S	FI-Wash. 7/16" I.D. x 1.38"
58	756-0350	1		1/2" "V"-Pulley .475" O.D. x 1.00" Bore
59	13819	1		Belt Guard
60	710-0520	1	/P	Hex Bolt 3/8-16 x 1.50" Lg.
61	712-0158	1	S	Hex Cent. L-Nut 5/16-18 Thd.
62	710-0780	1		Hex Bolt 7/16-14 x 2 00n Lg.
63	04970	1		Tine Adapter Assembly
64	742-0243	1	S	Tine-L.H.
65	731-0374	1	S	Flange Bearing 1.00" I.D.
66	748-0276	1		Spacer
67	736-0281	1	S	Thrust Wash. 1/2" I.D. x 1.55"
68	742-0244	1	S	Tine-R. H .
69	04995	1	S	Tine Assembly Comp.-L.H.
70	712-0241	1	/P	Hex Nut 3/8-24 Thd.
71	736-0119	1	S	L-Wash. 5/16" I.D.
72	710-0459	1	S	Hex Bolt 3/8-24 x 1.5" Lg.
73	712-0290	1	/P	Hex Cent. L-Nut 7/16-14 Thd.
74	04991	1		Chain Case Ass'y. Comp.
75	04996	1		Tine Assembly Comp.-R.H.
76	710-0376	1	/P	Hex Bolt 5/16-18 x 1.00" Lg.
77	712-0267	1	S	Hex Nut 5/16-18 Thd.
78	710-0237	1	/P	Hex Bolt 5/16-24 x .62"
80	04988	1		Clutch Support Bracket
81	738-0296	1	S	Shld. Bolt .435 Dia. x .265 0 5/16-18 Thd.
82	710-0412	1	/P	Hex Bolt 1/4-28 x .75" Lg.
83	720-0142	1	/P	Plastic Grip
84	738-0183	1	S	Shoulder Bolt .498 Dia. x .212 Lg.
85	747-0378	1		Clutch Handle
86	14298	1	S	Clutch Support Shroud
87	04519	1	S	Engine Mounting Bracket
90	710-0201	1		Hex Bolt 3/8-16 x .62" Lg.
92	04975	1	S	L.H.-Side Plate
	04976	1		R.H.-Side Plate (Not Shown)
93	04983	1	S	L.H.-Tine Shield
94	04984	1		R.H.-Tine Shield
95	710-0116	1	S	Hex Bolt 5/16-18 x 2.00" Lg.
96		1		8 H.P. Engine
97	738-0482	1		Hitch Rod
99	711-0700	1		Ferrule